

floral management

THE FLORAL BUSINESS AUTHORITY

MAY/JUNE 2022 | VOLUME 39 | NUMBER 2

Inside: Determine Design Wages p. 18
How to Handle Tipping p. 34
Prep Flowers for Outdoor Events p. 48

New Event Economics

Experienced event florists share new strategies to keep profit margins strong





Discover Accent Decor's newest Harvest & Halloween collections
celebrating the nostalgic whimsy of Fall

ATLANTA | BLDG 1, 18-E18 DALLAS | WTC 190 HIGH POINT | IHFC | H309 LAS VEGAS | C-124

ACCENTDECOR.COM • 770.346.0707

floral management

THE FLORAL BUSINESS AUTHORITY MAY/JUNE 2022 | VOLUME 39 | NUMBER 2



22 NEW EVENT ECONOMICS

Amid rising prices and other challenges, experienced event florists are finding new strategies to keep profit margins strong.

28 JOINING THE PARTY?

Wedding and event business is booming this year, but not every florist wants to join the party.

34 TIPS FOR TIPPING

Customers are increasingly tipping florists online and in store. Finance expert Paul Goodman, MBA, PFCI, breaks down how to account for and distribute tips.

2	VIEWPOINT	18	GROWTH
4	WHAT INSPIRES US	20	FRESH CHOICES
4	MORE ONLINE	36	INDUSTRY NEWS
6	AD INDEX	38	UP THE SUPPLY CHAIN
8	SAF IN ACTION	40	DIGITAL STRATEGY
10	MEMBER FORUM	42	BUSINESS OF DESIGN
12	HANDS ON	46	NEW PRODUCTS
16	TALENT	48	QUALITY

ON THE COVER High Mountain Flowers in Sedona, Arizona, saw a sharp increase in destination weddings last year, says owner Martha Aaron, AIFD. She made several changes to her wedding business to ensure flexibility and profitability amid rising costs and supply chain disruptions. For more on how florists are keeping weddings profitable, turn to page 22. Photo by Jonathan Allison Photography.



floral management

THE FLORAL BUSINESS AUTHORITY
MAY/JUNE 2022 | VOLUME 39 | NUMBER 2

AMANDA JEDLINSKY EDITOR IN CHIEF
AJEDLINSKY@SAFNOW.ORG

SHEILA S. SANTIAGO DIRECTOR OF DEVELOPMENT
SSANTIAGO@SAFNOW.ORG

KATIE HENDRICK VINCENT SENIOR CONTRIBUTING EDITOR
KVINCENT@SAFNOW.ORG

DESIGN AND PRODUCTION
CONTENT WORX

PUBLISHING ADVISERS
KATE F. PENN, SAF CHIEF EXECUTIVE OFFICER
KATIE P. BUTLER, SAF SENIOR VICE PRESIDENT

EDITORIAL OFFICES
SOCIETY OF AMERICAN FLORISTS
1001 NORTH FAIRFAX, SUITE 201, ALEXANDRIA, VA 22314-3406
(703) 836-8700
WWW.SAFNOW.ORG

ADVERTISING SALES
SHEILA SANTIAGO
SSANTIAGO@SAFNOW.ORG
(703) 838-5225

FLORAL MANAGEMENT (ISSN 1067-4772) (USPS-936-400) IS PUBLISHED BIMONTHLY BY THE SOCIETY OF AMERICAN FLORISTS (SAF), THE ASSOCIATION THAT PROVIDES MARKETING, BUSINESS AND GOVERNMENT SERVICES FOR THE ENTIRE FLORICULTURE INDUSTRY. STATEMENTS OF FACT OR OPINION IN FLORAL MANAGEMENT ARE THOSE OF THE AUTHORS AND MAY NOT REFLECT THE OFFICIAL POLICY OF THE SOCIETY OF AMERICAN FLORISTS. PERIODICALS POSTAGE IS PAID AT ALEXANDRIA, VIRGINIA 22314-3406 AND ADDITIONAL MAILING OFFICES. ALL MATERIAL IN THIS MAGAZINE IS COPYRIGHTED 2011 BY SOCIETY OF AMERICAN FLORISTS. ALL RIGHTS RESERVED. \$25 OF SAF MEMBERSHIP DUES REPRESENTS A MEMBER'S SUBSCRIPTION TO THIS PUBLICATION. SUBSCRIPTIONS FOR NON-MEMBERS ARE AVAILABLE FOR \$59 PER YEAR. SINGLE COPIES: \$4. MATERIALS MAY NOT BE REPRODUCED WITHOUT WRITTEN PERMISSION.

POSTMASTER
SEND CHANGE OF ADDRESS TO FLORAL MANAGEMENT,
1001 NORTH FAIRFAX, SUITE 201, ALEXANDRIA, VA 22314-3406.
PUBLICATIONS MAIL AGREEMENT #40589029. CANADIAN RETURN
MAIL ADDRESS: STATION A P. O. BOX 54, WINDSOR, ON N9A 6J5.
E-MAIL: CPCRETURNS@WDSMAIL.COM.

INSTRUCTION TO CONTRIBUTORS
FLORAL MANAGEMENT WELCOMES ARTICLES AND PRESS RELEASES TO BE SUBMITTED FOR POSSIBLE PUBLICATION. SEND TO: FMEDITOR@SAFNOW.ORG. ANY UNSOLICITED MATERIALS SENT, INCLUDING PHOTOGRAPHS, WILL NOT BE RETURNED UNLESS REQUESTED. FLORAL MANAGEMENT IS NOT RESPONSIBLE FOR THE LOSS OF PHOTOGRAPHS OR ANY OTHER MATERIALS SENT.

FLORAL MANAGEMENT IS A MEMBER BENEFIT OF THE SOCIETY OF AMERICAN FLORISTS. WWW.SAFNOW.ORG

LETTERS TO THE EDITOR
WE WELCOME YOUR FEEDBACK ON THE MAGAZINE. PLEASE SEND YOUR OPINIONS AND SUGGESTIONS TO: FMEDITOR@SAFNOW.ORG.

ON GROWING YOUR WEDDING BUSINESS

> My career as a florist traces back to my grandmother, Tommie Miles, a hometown florist who enjoyed sympathy work and vowed to never do weddings. Ironically, weddings and events are all I do. But it's taken a while — and a lot of change, innovation, and risks — to get where I am today, running a full-scale wedding and rental business all while traveling the country creating wedding designs.

So much has changed since I followed in my grandmother's footsteps and became a florist 15 years ago. In my early days of floristry, weddings weren't just cake, punch, and table centerpieces in the church fellowship hall. Weddings were about following the latest Martha Stewart trends, with brides bringing in folders full of magazine clippings. (Yes, this is what brides did before the days of Pinterest!)

When technology became more advanced and accessible, I began to see Pinterest boards, pins and even the occasional color chart. This definitely got my creative juices flowing. I loved brainstorming with brides about how we could make her wedding the best and truly make it an experience for guests. I thought I was making my best work yet.

Then came Instagram, and my floral career changed entirely. My viewpoint on wedding design expanded beyond florals. Originally, my goal had been to create beautiful bouquets, wedding backdrops, and buffet centerpieces. But once brides began using Instagram to source images from designers all around the world, they began to see the grandeur possibilities of incorporating patterned linens, floral ceiling installations, lounge furniture and bar/stage façades into their events. Right along with them, I saw the possibilities of leaning into this new concept, and by incorporating rental pieces into my business plan not only could I offer floral design, but I could also help set the scene for weddings and parties. With this plot twist, I found myself on a new path with endless possibilities.

Was it scary? Yes.

Was it costly? Yes.

Were rentals the perfect complement to my business? Yes.

With a few years of the rental business under my belt, I was confident in this new plan. I had amassed enough inventory to lay



the foundation for an event and let my floral designs be the finishing touch. And then in March of 2020, a gala with 100 tables canceled. That phone call was quickly followed by more and more cancellations. It was the beginning of a nightmare for every wedding florist.

My team and I rescheduled over 300 weddings and events during that time, and two years later we are just now wrapping up some of those postponed events. I am very thankful that I had diversified my business with rentals. Large weddings were canceled, but customers instead had small ceremonies and came to me for arches and other props, which helped my revenue stream during that difficult time.

Did I have moments of doubt? Yes.

Am I thankful that my business survived to see the boom on the other side? Yes.

As we embark on what's expected to be the busiest wedding season in decades, my advice is to be creative about your wedding and event business. Don't be afraid to diversify your inventory and services beyond those fellowship hall floral tabletop centerpieces. You might be surprised how it elevates your business and brand and tips the scale so brides choose you as their florist.

Can you do it? Yes. Yes, you can. 🌿

Mandy Majerik, AIFD, PFCI, owns and operates HotHouse Design Studio, which shares a roof with her rental company, PropHouse Birmingham, in Birmingham, Alabama. Mandy is a wedding designer and trend forecaster and works in product development creating florals as a catalog designer.



All the marketing you'll ever need

The TeamFloral **Total Marketing** program covers all your marketing needs by winning new customers and keeping existing ones. Best of all, it is the only marketing program for florists that has a money-back guarantee.



Find...

We get your shop higher and higher in Google search results so more and more customers find your shop.



Win...

The higher your Google review score the more customers pick your shop. Total Marketing delivers new 5-star reviews month after month, so you win more customers.



Keep...

Our unique remarketing system creates a personalized campaign for every customer, which keeps them coming back again and again.

Visit our website for more information

www.teamfloral.com/total

POISED FOR CHANGE



> How have you reacted to change these past two years? Did you fight it? Embrace it? Go with the flow? More importantly, did you learn from the change, and if so, are you using that knowledge to advance your business?

Those are the questions I hope you ask yourself as you read this month's cover story. We talked with several event florists who reacted to a changing market by adopting new business practices that gave them flexibility, a way to control costs, and most importantly, a healthy profit margin.

When we checked in with Vince and Carolyn Butera, of Butera The Florist, they told us that they think of change as a game of volleyball. When the ball crosses the net, the team must be quick on their feet to

receive it however hard and fast it comes. They've thought of this analogy often since 2020, when COVID-19 shutdowns forced them to close their retail store in York, Pennsylvania. They saw the closure as an opportunity to finally put into action their "42-year plan" of moving to Maine, where they got back to their roots as wedding-only florists.

Equipped with new strategies that came from challenging times, they and other florists are positioned to profit from what is expected to be the busiest wedding season since 1984.

Not every florist wants a piece of the wedding pie — er, cake. In our second feature story, we profiled florists who are stepping away from weddings, those who are ramping up their businesses to meet the demand, and those who are staying in the game — but with new rules. As Jordan Davis of Lafayette Florist, Gift Shop & Garden Center in Lafayette, Colorado, put it, "I adjusted my business model to make sure that my job is still enjoyable."

Ready to embrace change? Take a look at Growth on page 18 to see how you could change the daily routine in your shop to increase your designers' productivity. On page 20, Fresh Choices offers alternatives to the most sought-after (and sometimes hard to obtain) varieties of roses. In Up the Supply Chain on page 38, you'll learn how ocean freight continues to change how flowers are shipped ahead of major floral holidays.

We want to hear from you, too. What changes did you make to your marketing that generated results? Tell us by entering your marketing initiative in the Society of American Florists' Marketer of the Year competition, which is back after a two-year hiatus. The competition is open to any SAF retailer, grower or wholesaler with an original and successful marketing campaign. The winner will receive \$5,000 from Design Master, a division of Smithers Oasis, and be featured on the cover of the September/October issue of *Floral Management*. Go to safnow.org/moty for more information, but don't wait — the deadline to submit your entry is May 31.

Amanda Jedlinsky
Editor in Chief
ajedlinsky@safnow.org

More Online

HIRING STRATEGIES

Employers need to rethink the hiring process given the difficulty finding workers — and the workforce's new attitude toward their jobs. The Society of American Florists' "Grow Your Team" courses are available now on Career Connection. Human resource expert Glenna Hecht guides participants through each step of the hiring process, from writing job descriptions to conducting interviews, making smart hiring decisions and much more.

Enroll Now!

Course 1: Workforce Planning and Attracting Talent. safnow.org/hirenow

Course 2: Interviewing & Hiring. safnow.org/interview



SHUTTERSTOCK.COM/WAVEBREAKMEDIA

CATCH UP WITH ON-DEMAND WEBINARS

SAF's live, monthly webinars are always recorded and available on-demand. Watch any time for expert insights into the timeliest industry topics. SAF's recent webinars include, "New Sales Tactics for Today's Customer," "Strategies to Accelerate Deliveries," "Inflation, Supply and the Fed, Oh My! Charlie Hall's 2022 Outlook," and "Say This, Not That." View now at safnow.org/ondemand.



SHUTTERSTOCK.COM/EVGENY ATAMANENKO

MOTHER'S DAY MARKETING RESOURCES

Sunday, May 8, is Mother's Day! Prepare for a successful Mother's Day with resources, tips, and free social media graphics to promote your offerings and special promotions. Show your customers that flowers are the perfect gift for moms. Find Mother's Day social media graphics and content ideas at safnow.org/mdaysocialmedia.



 **Nachtmann**
FINE BAVARIAN CRYSTAL

Expertly curated by

oasis[®]
FLORAL PRODUCTS



In Stock and Available Now.

The luxury glassware your customers have been asking for!

Contact your favorite wholesaler or visit us at oasisfloralproducts.com to place your order and for design inspiration.

FIND WHAT YOU NEED

You can also visit advertisers online at floralmanagement.safnow.org.

Accent Decor 770-346-0707, AccentDecor.com Inside Front Cover

CalFlowers 831-479-4912 ext. 4, cafgs.org.....6, 7, 37

Chrysal 305-477-0112, chrysal.com39

Deliflor Chrysanten + (57) 310 504 8183, DeliFlor.com..... 15, 19

Details Flowers 386-255-9594, DetailsFlowers.com 41

Flower Clique 833-425-4783, FlowerClique.com..... 10

FTD 800-788-9000, FTDi.com/NEWFTD Back Cover

gotFlowers 408-840-3514, gotFlowers.com 17

Smithers Oasis 800-321-8286, OasisFloral.com 5

Syndicate Sales 800-227-3084, SyndicateSales.com/holly.....11

TeamFloral TeamFloral.com/scan 3

Teleflora 800-421-2815, MyTeleflora.com Inside Back Cover



Join CalFlowers for Deep Shipping Discounts



Up to 72.7% off FedEx Priority Overnight® & FedEx Standard Overnight® Services

Up to 39% off FedEx Ground®



More than 70% off standard GLS rates

Excellent shipping discounts on select U.S. Airlines

Reminder

Your business is not required to be based in California to be a CalFlowers member.

NEW!

Free Subscription to uBloom.com for all CalFlowers members



California Association of Flower Growers & Shippers

(831) 479-4912 ext. 4
cafgs.org • info@cafgs.org

SIGN UP NOW FOR FLORAL MANAGEMENT

YES

Please start sending Floral Management

- 1 year Domestic \$59
- 2 years Domestic \$94
- 1 year Foreign \$74

Call 703-836-8700 or visit www.safnow.org



**When you're
feeling yoga
pants more than
yoga practice.**



Flowers.

SELF CARE MADE EASY

that
flower
feeling

SAF MEMBERS VISIT CONGRESS TO PUSH FLORAL AGENDA

> Nearly 70 members of Congress and their staffs heard from floral professionals in Washington on March 29 about the industry's need for agricultural labor reform, access to duty-free product, and more funds for cutting-edge floriculture research.

Growers, wholesalers, retail florists and others with ties to the industry met virtually and in person with legislators and their staffs during the Society of American Florists' 42nd annual Congressional Action Days.

The floral industry specifically asked members of Congress to reauthorize the Generalized System of Preferences, which removes tariffs from certain imports — including roses; reform the H-2A visa program to make it more workable, providing a reliable, legal source of labor; and allocate an additional \$2 million to the Floriculture and Nursery Research Initiative to study the use of drones in agriculture. 🌿



(Left to right) Ryan O'Neil, PFCI, of Curate Floral Software in St. Louis, Missouri, and his son; Lynne Tischler, AAF, CPFD, PFCI, of Your Enchanted Florist in Saint Paul, Minnesota; Jennifer Barnard of Tillie's Flower Shop in Wichita, Kansas; and Rodney and Amy Crittenden of the Great Lakes Floral Association in Haslett, Michigan.



(Left to right) Dwight Larimer, AAF, PFCI, of Design Master, a division of Smithers Oasis in Kent, Ohio; Susie Palazzo of City Line Florist in Trumbull, Connecticut; Mike Black of Jet Fresh Flower Distributors in Miami, Florida; and Nicole Palazzo, also of City Line Florist.



SAF President Michelle Castellano Keeler, AAF, of Mellano & Company in Oceanside, California, with Rep. Dan Kildee (D-Michigan) at the Grassroots Breakfast.

"I've been attending CAD for 20-plus years and it never gets old. We are fortunate to have the opportunity to speak with our country's leadership about what's important to us."

—Rodney Crittenden, Great Lakes Floral Association



(Left to right) Malia Pere of BloomNet in Carle Place, New York; Sherry Grimes-Jenkins of EMY Custom Flowers in Mahopac, New York; and Ryan Alders of Alders Wholesale Florist in Campbell Hall, New York.

"By coming together and having conversation, we make a difference. Every office we visit amplifies the industry's voice on the Hill."

—SAF President Michelle Castellano Keeler, AAF, Mellano & Company

“It is always an eye-opening experience. It’s great to have a chance to share our personal stories and why these issues matter to our industry in order for us to stay in business.”

—Jennifer Barnard, Tillie’s Flower Shop



(Left to right) Augusto Solano of Asocolflores in Botega, Colombia; Sahid Nahim of New Bloom Solutions in Miami, Florida; Corrinne Heck, PFCI, of Details Flowers Software in Ormond Beach, Florida; Rep. Gregory Steube (R-Florida), Austin Bryant of Heart of Florida Greenhouses in Zolfo Springs, Florida; Renato Sogueco, AAF, PFCI, of BloomNet in Carle Place, New York; and Erik Hagstrom of Albin Hagstrom & Sons in Pierson, Florida.



(Left to right) SAF Senior Content Strategist Amanda Jedlinsky; SAF Chairperson Chris Drummond, AAF, PFCI, of Penny’s by Plaza Flowers in Philadelphia, Pennsylvania; and Kaitlin Radebaugh, AAF, of Radebaugh Florist & Greenhouses of Towson, Maryland, prepare for a virtual meeting with New Jersey Sen. Cory Booker’s office.

D.C. SCAVENGER HUNT AND DONATIONS BOOST SAF PAC FUNDS

> The “Race to the White House” scavenger hunt, held as part of the Society of American Florists’ Congressional Action Days, had attendees, in teams of five to six, running by landmarks such as the White House, Lafayette Square and the Treasury Department on a blustery day in a race to discover answers to clues.

Tickets to the event, along with nine donations of \$1,000 or more, raised \$12,000 for SAF’s political action fund — and gave attendees a fun way to quickly see Washington and interact with their floral industry peers.

“It was a great way to engage with people that you otherwise wouldn’t engage with,” says Steve Ozment, of Flowerama in Columbus, Ohio. 🌿



SAF members raced through Washington during a scavenger hunt to raise money for SAF PAC.

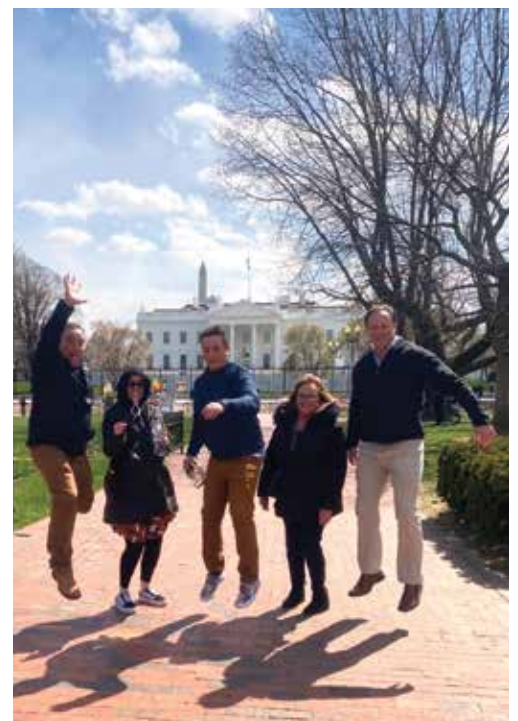

(Left to right) Steve Ozment of Flowerama in Columbus, Ohio; Kayla and Tanner Wheat of Lafayette Florist, Gift Shop & Garden Center in Lafayette, Colorado; Cheryl Vaughan of the Texas State Florists Association in Austin, Texas; and Tom Wolfe of Wolfe Wholesale Florist in Waco, Texas, getting in position for a photo challenge.



HEY YOU

STOP LOOKING LIKE EVERYONE ELSE.

Elevate your website from *meh* to magnetic with an all-inclusive membership that works *for* you.

Flower & Clique

WWW.FLOWERCLIQUE.COM • 1 (833) i-CLIQUE

REVVING UP REVENUE

> A recent survey by the Society of American Florists found that more than half of floral industry businesses closed 2021 with higher gross sales than in 2020. We asked members to share what helped increase revenue and why they are optimistic about this year.

“Working hard to increase our event sales has allowed us to buy at higher volumes and keep costs down.”

Marisa Guerrero, Debbie’s Bloomers, El Paso, Texas

“We are charging more for our service and delivery. If people want ‘cheaper’ flowers and/or designs, there are plenty of markets and florists that can do that. I decided what my quality, service and designs were worth and what people would be willing to pay.”

Marci Rasmussen, Especially For You, Salt Lake City, Utah

“We continue to refine our product SKUs to have higher values with less SKUs and push designers’ choice. We also have added a service fee to all online orders and enabled tips.”

Robert Aykens, Memorial Florists & Greenhouses, Appleton, Wisconsin

“Agreeing to take orders from the funeral home websites has been very impactful. Two additional local funeral homes (so now we have five) now use us exclusively for their discretionary work; we supply them with a floral selection guide that has a photograph of their facility on the front cover and it is already priced.”

Connie Butler, Botamer Florist & More, Elyria, Ohio

“We have kept the store very well stocked and marketed to past buyers for repeat occasions such as holidays and special occasions.”

Kevin Keser, Keser’s Flowers of Glastonbury, Glastonbury, Connecticut 🌿

WEDDING & EVENT ARCHES

NEW!



Featuring the
Holly Chapple Round
Installation
Mechanic! #372

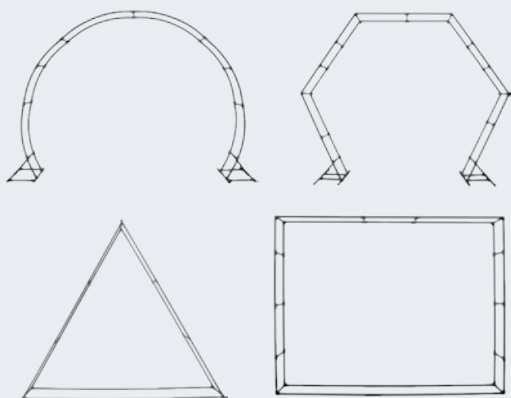

ARCH COLLECTION FEATURES:

Available in Round, Rectangle, Triangle & Hexagon
Round, Rectangle & Triangle shapes offer multiple sizes & configurations

Only one person needed for setup & installation

Made from a twisted steel process for strength and durability

Double layer construction for stability

Canvas bag for convenient storage & transport

**Pair with Holly Chapple Installation Mechanics
for endless design possibilities!**



Learn more or place an order at:
syndicatesales.com/wedding-arch

SNAPSHOT

Make a Statement — and a Sale — with Dried Botanicals

> Drying flowers has always interested Martha Aaron, AIFD, owner of Mountain High Flowers in Sedona, Arizona. “I did it before I even became a florist. As a child, I used to pick and press wildflowers. I dried my prom corsage. I’ve always loved flowers and preserving them,” she says.

Six years ago, when she moved from Houston, Texas, to Sedona to set up her studio, Aaron discovered a serendipitous perk: Sedona’s hot desert climate is ideal for preserving flowers. “Everything dries so beautifully and quickly here,” she says. “I started drying at home — my whole house was covered in hanging

flowers before long.” In her shop, she places stronger branches, such as eucalyptus, in vases, and uses dividing walls to demarcate areas for blooms that need to be hung to dry.

With dried botanicals trending in not just the floral industry but also home décor, Aaron finds herself well positioned to incorporate the in-demand material into both her wedding arrangements and retail displays.

“Aesthetically, dried botanicals partner well with our Red Rock formations and desert backdrop,” she says. “They jive with the boho look that our



DRAMATIC DRIED DISPLAYS A variety of dried botanicals arranged in vases make a stunning display at High Mountain Flowers in Sedona, Arizona.





brides are loving right now. Mixed with fresh blooms, our dried flowers, grasses, and pods add beautiful texture and dimension. They are also an ideal way to play with nudes and neutrals."

Aaron has experimented with drying just about every flower, with many successes and a couple failures. ("Kangaroo paw just breaks apart," she says.) Strawflower, protea, ranunculus, Limonium, lavender, rosemary, pods, eucalyptus, antique hydrangeas, spray roses, and certain standard roses are all excellent candidates. "Another perk of Arizona is that we have dry grasses everywhere," Aaron says. "Pampas grass, for example, is having a big moment in wedding florals."

On the retail side, dried botanicals are popular year round except November and December, when clients crave holiday looks. Otherwise, Aaron's dried offerings — including newer products such as wreaths and sealed jarred arrangements — comprise about 15 percent of the business's annual sales. "Sedona is a travel destination. We have a lot of Airbnbs out here, and those owners typically prefer permanent dried floral installations versus investing in fresh bouquets," she says. Seasonal residents, another key demographic, are drawn to the dried choice for similar reasons.

Designing for a predominance of destination weddings and elopements, Mountain High Flowers finds that many clients appreciate the ability to take their flowers home. One of the studio's recent creations featured on Instagram is a "forever bouquet," a textural explosion of pampas grass, dried palms, and bunny tails. Most designs, however, celebrate the region's iconic desert vibe with an artistic blend of fresh and dried.

For Aaron, the process of drying is the floral industry's version of recycling. She uses only leftover product, either overages or what remains after wedding breakdowns. "It's a great way to make money off blooms that you would otherwise throw away," she says. "I think the dried trend is going to be part of our business for quite a while. I think it's here to stay." 🌿

TEAM BUILDER

Focus on Fun to Make Connections

> The work atmosphere at Jet Fresh Flower Distributors, a Miami-based grower, importer and wholesaler, is informal and upbeat. Sales reps star in product videos for Instagram and YouTube. Birthdays are celebrated with silly string and cake. Reaching a sales goal wins you a bottle of bubbly, and new employees get a Nerf gun to prepare for random battles with coworkers.

While the company's founder and owner, Mike Black, is very serious about his flowers and customer service, he likes to keep his branding and marketing approachable — nothing too fancy or proper. "We are competing against 30 to 40 other wholesale companies doing exactly the same thing," Black says. "We prefer to market ourselves as real and relatable. Ultimately, we want our customers to feel like we can relate to their business needs."

Black started the company in 2008 by making phone calls from his desk. Today, Jet Fresh Flowers has 40 employees in its Miami office and nearly 100 employees at its Ecuador farm, Jet Fresh Flower Growers, SA. The company is family owned and operated, with Black's wife, Susan Black, handling the front office and two of his five sons, Ryan Black and Casey Black, working in marketing and sales, respectively. But it's Mike Black's ethos of mutual respect that trickles down from the top. "Everyone here is treated the way I would want to be treated myself," he says.

Besides benefits and perks, the company also supports employees by showcasing their expertise. Its preferred medium for putting their know-how and hard work on display? Video.

When Ryan Black, the company's marketing director, came onboard, he

brought with him a penchant for video creation (he studied computer animation and graphic design in college). Each week, he creates two to six videos, which are then posted to the "Jet Fresh TV" channel on YouTube. He regularly films Instagram Reels and TikTok videos as well.

The content ranges from informative (featuring different roses grown in Ecuador) and behind-the-scenes (filming their warehouse staff handling pre-holiday volume), to timely (showcasing a rose wall designed for International Women's Day). With warehouse employees, farm staff, sales managers, and even the boss himself starring in regularly disseminated videos, the result is that Jet Fresh Flowers feels accessible, friendly, busy, and knowledgeable.

"Our salespeople in particular are willing to participate because it helps them create relationships with their customers, most of whom they only know by phone," says Ryan Black. "We've been doing videos and sales team marketing like this for 10-plus years. For us, video is not just a COVID-19 fad."

"Our business is global," adds Mike Black. "Recently, our Ecuadorian team attended a trade show in Holland, and people were coming up to them because they recognized them from their videos. They were like rock stars," he says with a laugh.

In a quick-touch digital world, Jet Fresh Flowers is personalizing business relationships by placing the faces and personalities of its staff at the forefront of its marketing. "Other companies sell from nice offices all day, which is fine. But we're bringing customers into our warehouses, looking inside the boxes, talking to the workers handling the product," says Mike Black. "This focus on team beats static numbers on a screen any day." 🌿



MARKETING MOJO (Top left) Jet Fresh Distributors' "The Gerbera Guy" mascot posing with gerberas. (Bottom left) Jet Fresh President Mike Black during filming for Jet Fresh TV, the company's YouTube channel. (Right) Olga Ramirez, AIFD, and Kris "Pinky" Yllescas have fun while inspecting a shipment of pampas grass.

Jennifer Sperry is a contributing writer for *Floral Management* who focuses on lifestyles, florals and interiors.

NO, THESE ARE NOT DAHLIAS...

these are the next generation

DISBUD BALLS FROM DELIFLOR



Evidence



Zonar



Paladov Sunny



Paladov Dark



Paladov



Lorax



Lychee



Aragon



Ganache



Fuzzball



Magna



Abbey

DELIFLOR

LATIN AMERICA

www.deliflor.com

EMPLOYEE SPOTLIGHT

Lisa Bennett



Floral Designer, Sparks Florist Sparks, Nevada

> If you ask Lisa Bennett for some life advice, she'll say, "Figure out what you want to do, and don't be afraid to do it." Trained in journalism, Bennett took those words to heart when she decided to change careers and pursue her life-long passion: working with flowers. "I have an obsession with flowers," she says. "It started with my Italian grandmother who was devoted to flowers."

A certified Master Gardener, Bennett has a yard filled with flowers, paints flowers on canvas and in murals, and keeps arrangements throughout her home. She discovered she could have a career in flowers later in life, when she took a floral design course taught by the owners of Sparks Florist, Mike and Tony Fiannaca. "Two weeks into the class, I knew I wanted to work with them," she says. "Thankfully, the feeling was mutual."

My favorite part of the job:

"Working with flowers — they just make me happy! The cooler is a living color palette. Every flower is a bit of magic on a stem for me. I love the creative challenge of trying to put things together correctly. If you do it right, it holds the power to convey everything from shared sorrow to unbridled joy, and makes both recipient and seller happy in one fell swoop."

My supply chain strategies:

"If we don't get the flowers we planned on, we have to be flexible. I ask myself how I can make this design to value and still give the look the customer wants. It's like a puzzle. You're looking for pieces that fit together and make a beautiful end result. I had come to love monochromatic design, but supply chain issues have forced me out of my box. I've had to combine colors I wouldn't normally. We're doing more hand tied arrangements and use greens as a grid or armature more than we did before. With containers, we're on the third choice for some designs and make it work by spiraling stems inside the container."

Where I find inspiration:

"My biggest inspiration comes from the people around me. We have a lot of talent in this company. I also follow several florists online, including Françoise Weeks (@françoiseweeks), Hitomi Gilliam, AIFD (@hitomigilliam), Brenna Quan (@brenna_quan), and the Floral Design Institute (@floraldesigninstitute). Everything they do is art. It's not all practical for the shop, for delivery purposes, but I do this kind of design in my house."

If I'm not in the design center:

"I'm teaching my granddaughters to love flowers. They brag that they're the only thing Nana loves more than flowers. I also design flowers for myself. I have a basement that looks like it could solve this supply chain problem all by itself!" 🌿

Julie Martens Forney is a contributing writer for *Floral Management*.

TRANSFORM YOUR BUSINESS WITH A CLOUD SERVICE

Manage One Store or Multiple Stores

*Now
available in
Canada*

View and manage Inventory in real time

Use a unified dashboard for all locations

**Enforce consistent business rules across
websites and POS**

**Transfer orders, design tasks, delivery
requests, and inventory between locations**

Accomplish more with less resources

Find out more www.gotflowers.com/boost-profits



www.gotflowers.com



(408) 840-3514



info@gotflowers.com



SET DESIGN WAGES BY DETERMINING PRODUCTIVITY

> A shop's capacity to create arrangements has always been a balancing act. Too little design time available and you have an overloaded team; too much time and you have an overloaded payroll.

As shops faced a surge in sales and a drop in the availability of labor the past two years, a new realization emerged that helps florists deal with this long-time conundrum. A designer can produce far more than most shop owners realized. That is great news! There's better news: The more a person can design per hour, the more you can afford to pay them. Right now, there is no choice but to pay more to get the best design help.

Determine Productivity

Most designers are paid by the hour, so the easiest way to determine productivity is to see how much retail product each designer can produce per hour. If you're one of the shop's designers, put yourself to the test, too.

A designer should produce 10 times his or her hourly pay. A designer who is paid \$20 an hour should be producing \$200 per hour.

The first step is to measure how much each designer is capable of producing during an hour of uninterrupted time. This shows their potential.

The next step is to take into consideration the normal conditions your designers face in your shop. How much time do they actually have to design uninterrupted? Do your designers do double-duty and answer the phone and take orders, load arrangements into the van, or assist walk-in customers? Estimate how many hours per day a designer really has to design.

These two steps will reveal important information that will help your designers reach maximum productivity.

- You will learn what each designer is capable of producing and whether the productivity matches their rate of pay. Both you and the employee will be able to gauge whether they are earning their wages or if they need to find more speed.

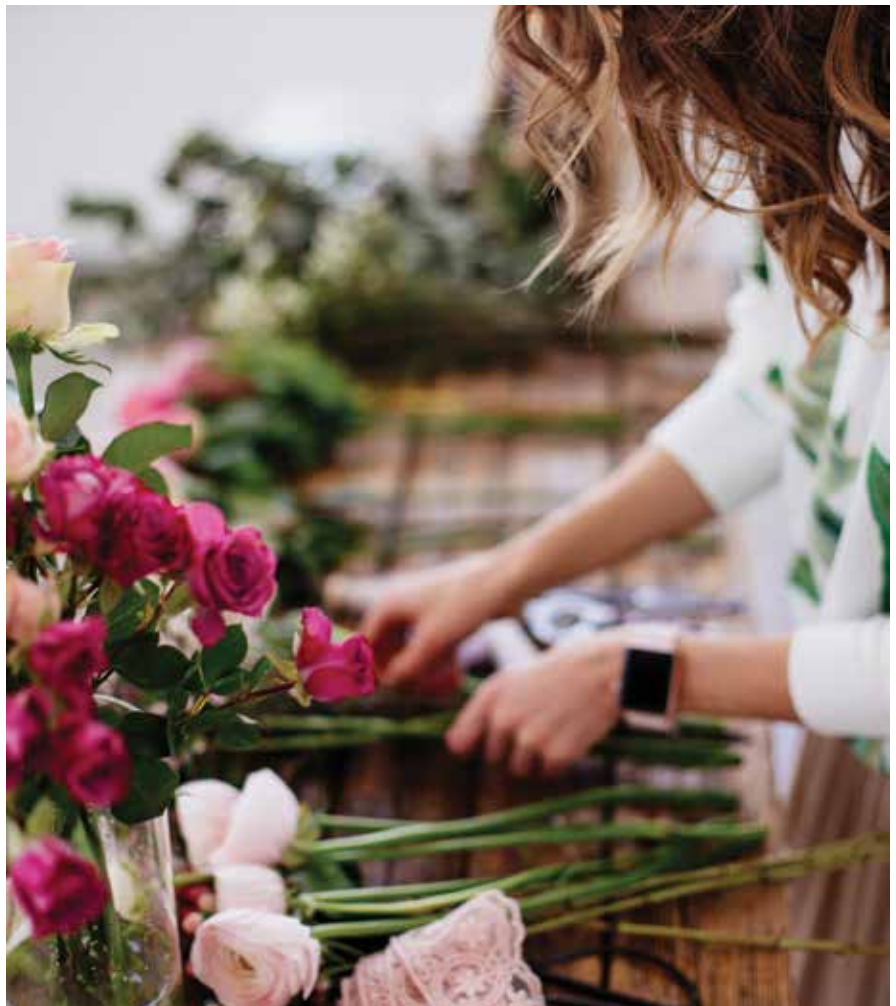

SHUTTERSTOCK.COM/ALINA KUIBASHNAYA

- You will see the difference between productivity potential versus what is possible in the circumstances of your shop.

Protect Designers' Time

You might need to look for ways to give your designers more uninterrupted time. For example, you could block off two or three hours every morning for them to work on designs while you and/or another employee take care of the front of the shop. A few adjustments could make a big difference in your design room productivity.

A helpful comparison might be to consider how a medical practice keeps their doctors productive. The doctors' time is the most valuable, so a team is built around them to make the most use of their expertise. They have a receptionist, an intake person and a nurse to help the

patient before the doctor is involved. You can create a similar support structure in your shop to protect your designers' time.

Keep in mind that you can afford to pay a designer 10 times what he or she produces per hour without limit. If you have a designer who consistently produces \$300 per hour, you can pay them \$30 per hour. Consider this: Once you have created an environment that maximizes designers' time (as in the example of the doctor's office), you will have the most productive designers and be able to pay the highest wages in town, which will attract the best talent — and keep your wages within budget. New times call for new strategies, and this may be one that fits your shop. 🌿

Dan McManus is the founder of **TeamFloral**, a marketing and consulting company for florists.



Magnum® Rosy

OUR VARIETIES

the best way to get closer



Magnum®



Magnum® Yellow

DELIFLOR

LATIN AMERICA

www.deliflor.com

RADIANT ROSES

> Blame it on social media. Pinterest and Instagram turned rose varieties such as 'Sahara', 'Quicksand', 'Free Spirit', and practically every David Austin variety into household names, and consequently, florists have scrambled to source these popular petals for years. Now, it can be downright impossible to get them, given the sheer volume of weddings scheduled, including so many postponed nuptials — not to mention the backlogs at ports and the increased competition for air freight, the ongoing truck driver shortage, and weather issues impacting farms' output.

* Winners of Red Ribbons in the Society of American Florists' 2021 Outstanding Varieties Competition



'SAFI'
Dümmen Orange



'IVY'
Dümmen Orange



'ROSE MAGIE'*
Presented by Danziger Flower Farm



'PLAYA BLANCA'*
Presented by Natural Flowers and Equiflor-Rio Roses



'QUEEN'S CROWN'
DV Flora



'COUNTRY SECRET'
DV Flora



'PHOENIX'*
Presented by Naranjo Roses SA



'SHIMMER'*
Presented by Agricola Circasia SAS C.I.
and Matina Flowers SAS



'ANDREA'
Dümmen Orange



'MOTHER OF PEARL'
DV Flora



'DEEP SILVER'
Dümmen Orange



'COUNTRY HOME'*
Presented by Natural Flowers

PHOTO BY BETSY HANSEN



'COLD BREW'
DV Flora



'WHITE ASHLEY'
DV Flora



'SHINE ON'
DV Flora



'GOLDFINCH'*
Presented by Matina Flowers SAS



'CLEMENTINE'
Golden Flowers

PHOTO BY BETSY HANSEN

PHOTO BY BETSY HANSEN



'DISCLOSURE'
Dümmen Orange

More than ever, suppliers are preaching the importance of flexibility. Confident in the staying power of the strongest color trends (whites and blushes; bright, tropical shades; “muddy” tones of caramel, beige, gold, and bronze; and gray-silver neutrals), wholesalers have been searching for some phenomenal — albeit less famous — alternatives to make brides’ dreams come true. Here are some of their top recommendations, which include several varieties that won red ribbons in the Society of American Florists’ 2021 Outstanding Varieties Competition. 🎀

Katie Vincent is the senior contributing editor of *Floral Management*.





New Event Economics

Amid rising prices and other challenges, experienced event florists are finding new strategies to keep profit margins strong.

BY JULIE MARTENS FORNEY

A record-breaking wedding season and supply chain disruptions combined to create an unforgettable 2021 for event florists. Challenges piled up fast, but business owners faced them with finesse — and learned new ways to thrive and maintain healthy profit margins.

“In business, it is very tempting and very easy to get in a rut of ‘this is the way I do things’ because you see success,” says Carolyn Butera, who with her husband, Vince Butera, AAF, AIFD, PFCI, owns Butera The Florist in Sedgwick, Maine. “The point is that the world is changing. The world will keep changing. And business changes.”

The Buteras began rethinking their business model during the 2020 shutdowns. Ultimately, they decided to get back to their roots as a wedding-only florist. In 2021 they permanently closed their 42-year-old, full-service retail business in York, Pennsylvania, and relocated to a small, coastal town in Maine that’s popular for destination weddings. Along the way, the Buteras refined the way they handle weddings to meet the challenges of today’s market.

RISING TO NEW HEIGHTS

Mountain High Flowers in Sedona, Arizona, saw an increase in destination weddings and had to adjust business practices to meet demand and keep costs in check.

They remind themselves frequently to be ready for change, and they challenge other florists to do the same. “How can you remain poised with a readiness to respond to opportunity with the changes that occur?” Carolyn asks. “Because they are going to occur. So much of this is out of our control.”

Like the Buteras, Martha Aaron, AIFD, owner of Mountain High Flowers in Sedona, Arizona, designs florals for many destination weddings. Last year, Aaron’s elopement and micro wedding business “skyrocketed,” she says. She, too, moved swiftly to implement new practices that offered her and her clients flexibility — and kept costs in check.

With their new strategies against rising costs and supply issues, these florists are ready to take on what is expected to be a blockbuster year for weddings. Aaron has a full schedule of weddings, and the Buteras experienced immediate bookings after their business moved to Maine. Other florists are also reporting record amounts of weddings and events.

“We can see how many events are being produced by our clients, and they’re breaking numbers every month,” says Corrine Heck, PFCI, a former wedding florist who founded Details Flowers Software, which helps florists manage ordering for events.

With the right strategies in place, it could be a record year for profits, too.

Charge for Everything

“In this market, florists have to be keen and astute on their margins,” Heck says. “We suggest to our clients to add an administrative fee, a blanket 5 to 10 percent.” This fee covers all the time a florist spends doing the administrative parts of the job, such as proposal writing, consultations, phone calls and even credit card charges.

Also consider charging for tasks that are normally done for free, such as boutonniere pinning. “I remember running around resorts trying to locate groomsmen to pin bouts,” Heck shares of her days as a wedding florist. “I started charging a fee to pin them. I’d arrange to be at a certain spot at a specific time to help pin bouts. By setting that fee, I set a boundary with my clients.” She suggests framing a boutonniere pinning fee by asking the client if they’d like to use your





COST SAVERS, MONEY MAKERS Butera The Florist lowered operating costs by limiting their rental inventory to basics, such as candles. Corrine Heck of Details Flowers Software says that wedding florists need to charge for everything, including services to pin boutonnieres.

pinning service for \$75. “If the client declines, respond by saying, ‘Then I’ll deliver the bouts to your room with your bouquet.’ At that point, they’ll always buy the extra service.”

Aaron has honed in on tracking supplies better as a way to curtail loss. “I’m more conscientious about set-up now. For instance, I didn’t always charge for back-end stuff like cages or foam for centerpieces. Now I’m making sure I’m charging for all the hardgoods that I didn’t account for in my recipes,” she says.

Vince adds that it’s important to charge for labor. “You need to be paid for what you’re doing. The way I price out labor, the charge is sometimes greater than the flowers themselves. Don’t sell yourself short.”

Change Pricing and Payment Structure

Because everything in the event business is presold, there’s always a chance — especially in today’s inflationary market — that prices will increase after

you’ve been paid. Vince tries to stay ahead by setting prices high enough to cover unforeseen price increases, and by keeping cost of goods low. “I’ve been told many times I’m more expensive than so-and-so, but I work very hard to achieve in the neighborhood of 18 percent cost of goods sold in fresh flowers simply because weddings take so much time.”

Aaron has also increased prices for flowers and supplies. She’s also changed her payment deadlines to give her clients flexibility and avoid going over budget due to price increases. “The major thing we have changed with events is that we used to utilize 30 days out for final payment,” she says. “We changed that to finalization and full payment no later than 18 days out. We cut it to the least amount of time we could have to get flowers ordered and still have wiggle room for the bride and groom if people couldn’t come.”

She does order specific, high-value items 30 days out and includes any large purchases for new rental items in the

nonrefundable deposit. “I’m a smaller business and keeping that final payment 18 days out has helped us with not having to give anything back to clients who had to cancel last minute. That really saved us when COVID-19 first hit. Now we’ve kept that 18-day mark as a procedure.”

Aaron pre-books flowers with her wholesalers but doesn’t place the order until the 18-day mark. “At that point, when I get approvals back from the wholesaler, if I’m overbudget, I’ll adjust and make sure I stay profitable on our end. I might think the market price is at one place, but with the changing market, it’s not. This procedure has really helped us out with cost of goods in 2020 and 2021.”

Ryan O’Neil, PFCI, founder and CEO of Curate, an event software, emphasizes that however a florist is creating proposals, they should be using the high average price of a flower to account for price fluctuations. “You don’t know what that pricing is going to look like in six to 12 months,” he says.

Evaluate Delivery Fees

Rising gas prices necessitate evaluating delivery fees. "I realized that I can't really increase my sales in bouquets, but am I making money on delivery and installation?" Vince says. "I realized I was not. I was just charging a nominal fee to get it there. In the past year or two I've honed in on charging a fair amount for installation and delivery. In most cases I base it on what I project for installation and travel time. I have a basic rate that I use to estimate that includes a designer (me), an assistant (Carolyn, my wife) and our vehicle."

Aaron is also rethinking delivery. "I've always used a standard delivery fee for micro weddings, which is usually a simple dropoff, but I charge more for that now," she says. "Sometimes my drivers need to make sure the bride is happy or show her how to hold the bouquet. I now charge \$25 for a wedding delivery versus \$10 for an in-town retail flower delivery. It just made sense with the increase of having so many weddings at one time."

Examine Purchasing Practices

"One of the biggest ways florists lose money is not maximizing design recipes to use full bunch counts," Heck says. "Maybe you need five garden roses for a bride's bouquet, so you buy a bunch of 12. What are you going to do with the other seven? That's money you're losing. It's great to have a plan and maximize the sale on each design."

O'Neil also cautions against having too many leftover flowers, noting it can be hard to sell premium flowers in the store and that what may seem like a small cost adds up over time. "If flower costs are going up, you have to clean up expenses," he says. "There is no room for slacking there."

For Butera The Florist, not having a retail store through which they can sell extra stems has forced Vince to adjust purchasing. "I look for different ways to lower stem costs. I'm not committed, for example, to having 12 roses in a bridal bouquet. If I map out my buying list and need 27 roses of one variety, that means I can't afford to buy 50 roses to get two more. I have to adjust the menu and get rid of two roses



DESIGN DETAILS Butera The Florist carefully maps out design recipes to avoid buying more flowers than needed. They also buy certain flowers in cases because it is less expensive than buying bunches and allows them to embellish bouquets.

somewhere. That's one way I've done it," he says.

Over the last 18 months, he's also started to buy fillers that store well, such as eucalyptus, in greater quantities. "There were plenty of times I only needed half a case but knew I needed half a case the next week, too," Vince says. "So, I buy two weeks of foliage and get a quantity discount."

He has also found at times that it was cheaper to buy a case of ranunculus rather than just the five bunches he needed. "At that point, I'm able to embellish bouquets," he says. Vince also has a few standard flowers that he buys in case quantities, which lowers costs. He suggests using the same strategy when buying basic supplies.

Manage Inventory

Tracking inventory is crucial to avoid double-booking rentals and scrambling to order more items, that are often expensive, O'Neil says. He recalled a time when he and his wife owned a flower shop and each of them promised a different couple their one set of white pillars for the same day. "There's too much opportunity for error," he says. He recommends using inventory software to prevent overbookings.

Heck ties inventory management to branding and setting boundaries. "Having too many options in terms of product lines is not a great way to do things," she says.

The other thing that can whittle margins is leaving product or rentals

behind. "Misplacing inventory can be a huge loss for event florists. It's vital for florists to collect all of their inventory at the end of the event," Heck says.

The Buteras have lowered their operating costs by drastically limiting rental inventory. "I have a few basics — glass flutes, metal stands — things I've used for years in various ways and are pricey for a client to buy," Vince says. "However, I assist my clients in procuring containers they want. For example, if they find something on Etsy as a container, they'll share the info with me and I make sure it's useable from my standpoint."

Carolyn adds, "During consultations, Vince doesn't promote excessive rentals that we can't carry ourselves. That comes back to knowing what our brand is and what we do well. We don't feel bad about referring our clients to another professional for rentals or other things they may want."

The Buteras have eliminated every product line except candles for weddings and events. "Extracting and limiting has been very important to our brand," Carolyn says.

Build Alternate Revenue

Aaron has developed a new revenue stream in the last year with dried flowers. "It's so trendy, and it's not humid here, so we dry our own flowers. I sell a lot of them," she says. In the store, if any flowers are about to turn or there's extra, they get bunched and hung to dry. (Check out her dried floral display in Hands On on page 12.)

Because Sedona is a destination city, not every bridal party takes their flowers with them. Left-behind flowers typically get processed in one of three ways: donated to local nursing homes, used again if stems are fresh, or hung to dry. "Our retail customers like buying the dried bunches. They often use them in bridal bouquets."

Dried materials also include locally harvested grasses, greenery and curly willow. The cost? Aaron's labor to cut and the storage fees. "I have five buckets of pampas grass stashed in a storage unit that I just cut from one of the resorts we work with. It's like gold," she says. The shop uses the grasses in holiday decorations and as part of the boho wedding look many Sedona brides want.

Find Value in Design Skills

Thoughtful arranging, backed by knowledge of design techniques and experience with mechanics, can also lead to cost savings. "There are tried and true design techniques that really have been lost in translation over the last 50 to 75 years," Heck says. "If you can learn to create beautiful designs with less product, that's another skill that will serve your business well. You could use less quantity of flowers but get paid more for them."

Vince cautions florists not to confuse creativity with freewheeling. "Real

creativity comes from a knowledge base that you've acquired over the years. If you have knowledge, it opens your mind to improvise and do something different — that's innovation.

"If you learn to design well, learn the elements and principles of design and mechanics, you have a toolbox of ideas that on the spot you can pull out something that's never been done before, and it will be a, wow, moment. But you've got to plan and work ahead for that." 🌿

Julie Martens Forney is a contributing writer to *Floral Management*.

A Brand with Boundaries

Recipient of the Society of American Florists' 2015 Marketer of the Year Award, Butera The Florist stays keenly focused on their brand.

One of the greatest lessons owners Vince and Carolyn Butera have learned is to "find your brand, define your brand in writing, and refine your brand over time. For us, that meant extracting from our brand what we're really good at and limiting our product line to only that," Carolyn says. "We're good at fresh floral botanical artistry. We can only do a few things well. That sounds counter to the trend of being all things to all people, but our more, narrow product line makes it easier to set boundaries. We know what we're doing — and what we're not going to do. We focus and work to our strengths."



What does that look like in application over the last two years? "One example is that we only deliver within a one-hour radius. Because of our presence on Wedding Wire and The Knot, this means we turn away clients daily," Carolyn says. "It's tempting to take them on, but a wedding in Kennebunkport [Maine] means an eight-hour day for us. We're not doing that."

The Buteras focus on catering to destination weddings because they believe those types of events are the best fit for their brand.

Setting boundaries is also a part of the business model at Mountain High Flowers in Sedona, Arizona.

"Events are a huge part of our business, but even last year, with weddings being so big, it only accounted for about half of our total business. The other half is full retail," says owner Martha Aaron. "I've always had a passion for the retail side and servicing our community, so I never take weddings on Valentine's Day or Mother's Day. That's when I focus on my community repeat customers." —Julie Martens Forney

JOINING THE Party?

Florists weigh whether to ramp up business to meet record-breaking demand for weddings.

Wedding and event business is booming this year, but not every florist wants to join the party. Dubbed “The Year of the Wedding,” 2022 is expected to bring 2.6 million weddings, the most since 1984, according to The Knot Worldwide, a global media group that surveyed more than 7,500 engaged couples to gather data. “This boost in demand isn’t going away anytime soon,” says Hannah Nowack, The Knot Weddings Editor & Expert. “2023, and possibly even 2024, are shaping up to be big years for weddings as well.”

That doesn’t mean that every florist will cater to the demand. In fact, the pandemic spurred many to rethink their wedding and event business models and reconsider what type of work they want to take on. While some are growing their business to meet demand, others are setting boundaries with the type of work or client they’ll take, and some are finding success in other areas, such as corporate events, sympathy work and even new product lines.

REFERRALS ONLY Nic Faitos of Starbright Floral Design in New York City focuses on building relationships with corporate clients whose events are often annual, easier and more lucrative than weddings, Faitos says. He is selective about weddings, only accepting wedding work from referrals by existing clients.



KEEPING THE WORK 'Enjoyable'

Jordan Davis
*Lafayette Florist, Gift Shop &
Garden Center, Lafayette, Colorado*

Jordan Davis, website manager and event coordinator for Lafayette Florist, Gift Shop & Garden Center in Lafayette, Colorado, is the shop's go-to wedding expert. "Our wedding business has greatly increased from year to year," says Davis, who recently stepped away from hands-on floral work and hired a team of designers so she could focus on the business side of wedding work. "In 2019, I did \$65,000 in weddings and I thought that was amazing. Then last year, I did \$120,000 in weddings, which is now my new standard." Davis hired an assistant last year to handle all those bookings and proposals.

"The pandemic definitely made me consider what kind of wedding florist I want to be and how to market to those brides," says Davis. "I want to work with more budget brides, flexible brides. I don't want to work with brides that need to know every single flower in their bouquet, or if they don't have the right color of peach they're going to have a meltdown. The stress level just became a bit too much. So, I adjusted my business model to make sure that my job is still enjoyable."

First, Davis revamped the wedding portion of the shop's website. Her goal was to streamline the entire proposal process and better serve her target market, mainly couples with smaller budgets. In addition to creating visuals of bridal bouquets, organized by color,

style, season, shape and type of flower, she included a page for sample corsages and boutonnieres. "A lot of brides don't know where to start, but if they look at those categories, then they can react — like, 'Oh, I like this. I don't like this,'" Davis says.

Davis also put a questionnaire on the website so brides could fill out the details and make design decisions independently. Then, based on the completed questionnaire, Davis fires off a proposal, saving hours normally spent hashing out what the bride does or doesn't want for her big day.

In addition to setting no minimum for wedding flowers, Davis created a page for micro weddings. She also created a page with elopement packages at four price levels (small to lavish). "After the bride gives me her style and color scheme, I choose all the flowers," Davis says. "I can pick whatever looks best and that's seasonal. I'm not stuck in this box. If a certain kind of flower comes in and doesn't look great, I don't have to use it."

Another part of Davis's new business model is that she no longer does installations. "That's where I draw the line," she says. "I won't hang stuff from your ceiling. I won't do any type of liability work. It just gets too overwhelming for me." She also won't deliver florals more than 45 minutes away for destination weddings. If couples want to pick up their florals, she's fine with that. In fact, she's even launching DIY wedding floral boxes that contain the number of centerpiece containers and florals couples want for their event.

GROWING TO Meet Demand

Mary McCarthy
*The Blooming Idea,
The Woodlands, Texas*

At The Blooming Idea in The Woodlands, Texas, weddings and events account for about 25 to 30 percent of owner and lead designer Mary McCarthy's business. The rest of her work is everyday flowers and funerals. "I love doing weddings and prefer that to the daily work and funeral work," she says, explaining that every wedding is unique and allows her creativity to shine. McCarthy aims to take advantage of the increased demand for weddings and events this year.

"My aim is to grow the business and take on more work," she says. "This year I took on two full-time workers and one part-timer. I felt if I'm going to increase the weddings and I'm going to do larger weddings, then I'd need more staff to accommodate the delivery and setup."

McCarthy also changed her website. "I found a lot of brides were price shopping," she says. "I was getting a lot of inquiries and spending a lot of time sending out proposals and getting ghosted. Last year I saw a demand for micro weddings where the brides just wanted to pick up the flowers and then those brides who wanted to go all out for full-service weddings. So, I could see I was getting two distinct type brides, and I wanted to service both." To do that, McCarthy put pages on her website for

"The pandemic definitely made me consider what kind of wedding florist I want to be and how to market to those brides."

—Jordan Davis, Lafayette Florist, Gift Shop & Garden Center

full-service weddings and increased her minimum to \$3,500. Then she added an à la carte section for micro weddings with visuals and pricing on site. This way, brides could immediately see the cost and style of bouquets McCarthy offered, then reach out if they wanted a consultation and proposal.

Not only is McCarthy getting more inquiries than ever before but also they're coming from brides who want to work with her. She's also saving everyone's time by conducting about 60 percent of her consults by phone or Zoom. "A phone consultation with brides saves them time spent traveling, and yet they still can choose inspiration pictures with me, and I can share pictures with them," McCarthy says. "I think they appreciate that because they're pretty busy."

To enhance the site's wedding floral visuals, McCarthy has started doing more styled shoots. "I work with other vendors — with the venue, with photographers, the make-up artist — and I provide the florals," she says. "We set up mock weddings and the wedding photographers take all these professional photos that I can use on my website. Plus, it's good networking getting to know different vendors."

IDENTIFYING A *New Niche*

Barbara Johnson

Simply Beautiful Floral Designs, Los Angeles, California

In 2016, after 25 years of running a floral business in Denver, Colorado, Barbara Johnson relocated to Los Angeles, California, where she set up shop as founder and owner of Simply Beautiful Floral Designs with her daughter. It was a chance to start afresh and drop the exhausting wedding work that had consumed 50 percent of her business in Colorado. "After doing so many weddings for so many years, you reach a level of burnout," Johnson says. "Brides are very difficult, very intense, and it's a labor-intensive industry. I had just reached a level where I no longer had any interest in that area." In Los Angeles, Johnson realized that she'd need a massive staff if she were to do wedding work. "We're in Hollywood and it's, go big or go home, and we found out that it was really, really hard to nail down a stable group of wedding design specialists unless it

was your primary business," she says. Ultimately, weddings were too much of a headache.

But Johnson didn't have to worry about getting business — she'd identified her niche when she opened — the unserved minority sector. "We were contacted immediately because we hit all of the areas that people were really looking for," she says. "We are a black-owned shop, female-owned business, and small business." Customers, including celebrities, found Johnson even though she hadn't done any advertising.



NEW NICHE Barbara Johnson (at right, with her daughter) did wedding work for 25 years in Denver, Colorado. She found the work exhausting and is focusing her new Los Angeles, California business on sympathy work for minority clients.

Her sympathy work skyrocketed during the pandemic, especially among certain cultures, such as the Vietnamese and Korean communities, who look upon death as a celebration of life. In addition to providing copious florals for what was often a multi-day event, she made and sent floral arrangements from friends and family who could not attend the event in person. "My business was attached to a mortuary and a very, very prominent one at that," says Johnson. "So, we were just inundated the first year and we grew so quickly it was almost unreal."

Johnson and her daughters (her second daughter now helps with the business) are still working to build the business in other ways. When spas and salons had to close during the pandemic, they had the idea to sell essential oils, healing candles and CBD. Now, Johnson wants to incorporate some of these products into her arrangements. When a client orders a bouquet, they'll receive flowers, along with a dose of health and wellness, she says.

BECOMING A *Well-Rounded* FLORIST

Ace Berry

Fulshear Floral Design, Fulshear, Texas

Ace Berry, owner and creative director of Fulshear Floral Design in Fulshear, Texas, has never done much wedding work. "The majority of my work is retail floristry and funeral work," he says. "Before COVID-19, I was doing three to five weddings a year averaging in size from \$2,500 to \$7,500," which comprised about 10 percent of his business, he says. Now, things have changed.

"For the latter part of 2021 and into 2022, I noticed that many florists weren't able to take on weddings," he says. "So, I started focusing on being a more well-rounded florist with more weddings." So far, Berry has approximately 10 weddings on the books ranging in size from \$5,000 to \$17,000. "They're in the small to medium range of weddings, but it's a good amount of extra income," he says. "You're looking at anywhere between \$50,000 to \$75,000 extra a year, and in some cases, an extra \$100,000 in the bank." To handle more wedding work, Berry hired additional employees and built a wedding department.

"I've noticed that a lot of friends that just did events are trying to get out of the business — COVID really took a toll," Berry says. "For me, it taught me to streamline my business and get rid of things I don't need and embrace the things that do well." Case in point, Berry ditched his line of home goods that weren't selling and leaned more heavily into wedding work. "I would love for weddings to be 25 percent of my business," he says. "I used to feel that I didn't have time to give wedding work my all. Now, what I've realized is that I have a bit more time because I figured out ways to do it better."

Aside from using event design software, Berry has begun doing styled shoots to enhance the visuals on his site. He also recently hired a social media manager to increase his presence on Instagram. "I've noticed that's where many brides find their florists, wedding venues and honeymoon destinations," he says. "And the next rounds of brides are going to be through TikTok."

FOCUSING ON *Relationships* THROUGH EVENTS

Nic Faitos

*Starbright Floral Design,
New York City*

Nic Faitos, senior partner at Starbright Floral Design in New York City, has no intention of chasing the wedding market, no matter how big it's going to be. "I'm out of the wedding business and I'm going to let everyone else fight over weddings," he says, noting that his focus has always been business-to-business work. "Our clients are Fortune 500

"We're not necessarily always looking for the profit on the individual event, but more focused on the long-term relationship."

—Nic Faitos, *Starbright Floral Design*

companies and event planners outside the social market," he says. "Now, that doesn't mean we don't do social events, but we do them very, very selectively and only through referrals from our existing clients."

Faitos has found that his corporate clients consistently hire him for their events, which are faster to book, more lucrative, and less time-consuming than weddings. He can count on annual galas such as the Golden Goggle Awards presented by the USA Swimming Foundation and Ernst & Young's Entrepreneur of the Year Awards. The event planners who work with him know he'll deliver gorgeous florals every time, he says.

While many of Faitos' clients closed their businesses during the pandemic, Faitos still found a way to serve them. Instead of doing the weekly flowers for their reception areas, lobbies and public spaces, as well as caring for regular and leased plants throughout their offices, he catered to individuals within each company. "There were a lot of people who work for businesses that wanted flowers," says Faitos, for themselves, their family, friends and colleagues. What's more, his staff began cold calling human resource departments to open up new accounts. And many signed on during the pandemic, says Faitos, placing increasingly larger orders as the pandemic began to wane. In fact, Starbright Floral Design handled the flowers for 73 corporate holiday parties in the first 11 days of December before Omicron hit.

"If we have an established relationship with an organization, a client or planner, if something needs to be done, no matter how last minute it is, no matter what the budget is, we do what needs to be done," he says. "We're not necessarily always looking for the profit on the individual event, but more focused on the long-term relationship." Indeed, Faitos has hundreds of loyal clients and Starbright Floral

Design has an annual revenue of slightly less than 10 million dollars, he says.

"In order for any florist to survive in any economy and at any time, they have to diversify," Faitos adds. "So, it's not that we don't do weddings; we just don't pursue them. Another good example of that is funeral homes. We've never dropped off a business card at a funeral home, but of course we do

funerals. I want to promote my industry and brand where nobody has thought of marketing and promoting flowers. And if I'm doing that successfully, I'm growing my business and not taking away somebody else's business." 🌿

Victoria Abbott Riccardi is a contributing writer for *Floral Management* magazine.



CORPORATE CONNECTIONS Starbright Floral Design has built a following of loyal corporate clients who turn to the florist year after year for event work.

EDITORS' NOTE *Paul Goodman, MBA, PFCI, and Derrick Myers, CPA, CFP, PFCI, love a good financial management challenge, however big or small. Send your questions to fmeditor@safnow.org, and we'll challenge the experts to tackle them in an upcoming article.*



Tips FOR Tipping

BY PAUL GOODMAN

SHUTTERSTOCK.COM/NTL STUDIO

Is accepting tips a good idea? Do customers leave tips? How do florists handle the distribution of tips? The emergence of tip jars at florists' shops — and on their websites — creates a host of new questions.

When you think of tipping, you normally think of restaurants, delivery drivers or barber shops and salons, but the pandemic sparked the trend of consumers and businesses thinking about tipping more broadly. Generally, the service staff at a restaurant is paid a "tipped wage," which is less than minimum wage, so they depend on tips to earn more money. One would never — or rarely — consider tipping at most retail stores. So, where do retail florists fit into the tipping scene? Historically, they haven't, except for an occasional tip to a driver.

It's true that for the most part the floral industry is a 'low-wage' industry, however, not nearly as low as restaurants. Many florists feel that the customer is already paying a lot for arrangements, and they don't want to solicit more money. Others say that tipping, when done properly, is not pushy and strictly voluntary. Wherever you land on that spectrum, here are a few guidelines for handling tips.

When and Where Does the Customer Tip?

Most customers leave a flower shop without tipping. Even if you have a tip jar on the counter, it's probably not used much. Most tips come from orders that are placed online. Florists will often include a tip jar in the add-on section of their website, with suggested amounts of \$3, \$5, \$8, \$10 or a place for the customer to add a different amount. The tip jar also appears on some websites during the checkout process.

It is not unusual for customers who have tipped online to inquire about adding a tip when phoning in an order.

Who Gets the Tips?

Some customers will tip the designer and others will tip the driver, or both. Keeping track of who designed what arrangement and who delivered each order that had a tip attached creates a lot of work. The florists I've talked with have decided to put tips into a tip pool, which is then divided between the employees. (Management is excluded from receiving tips.) The total amount in the tip pool is divided by the number of hours worked for a set period by all nonmanagement employees to get an hourly rate for tips. Then, that hourly rate is multiplied by each person's hours worked to determine their share of the tips. For example, suppose the tip pool has \$1,000 in it and the total number of hours worked by nonmanagement employees during that period was 1,000. Divide the \$1,000 by 1,000 hours and you get an hourly tip rate of \$1.00. If someone worked 40 hours during that period, they would get \$40.

There is an exception. Drivers and employees who work on special projects or events and are tipped directly by the customer are allowed to keep those tips.

What About Taxes?

Federal and state governments want employment and income taxes to apply to tips as well as wages. That's why it is important to run all tips through your payroll system. The tips need to be included in the shop's payroll tax calculations with each payroll period and in each employee's W2. This can be done in two ways.

First, add the tip amount to the wages for the payroll period and pay them out with wages at payroll time. This is probably the simplest way to handle tax and accounting issues associated with tips. However, many employees enjoy being handed cash. If you want to dole out cash to keep employees motivated, you would add the tip amount to the wage calculation and then subtract the amount you give out as cash as an advance on the payroll records. This requires an extra accounting step, and if most of the tips were submitted online, you will need to get cash from the bank and count it out for each person. It's well worth the extra effort to give cash given the impact it has on employee morale.

Many florists feel that the customer is already paying a lot for arrangements, and they don't want to solicit more money. Others say that tipping, when done properly, is not pushy and strictly voluntary.

One practical point: An employee's tip most likely will not come out to an even amount. Rather than hassle with pennies, round down to the nearest dollar and hand out bills, but use the exact tip amount — including cents — for payroll purposes.

How Often Should Tips be Distributed?

This depends on how much is in the tip pool. You don't want to give out a couple of dollars. That doesn't seem worth it to anyone. Many florists distribute tips quarterly when the hourly tip rate is high enough to make a real impact. However, that may be too long to wait, especially if you get a lot of tips. One florist told me that her employees were averaging \$2.50 per hour in added wages from tips. That adds up to a significant amount and

can be given out more frequently. If your shop consistently collects a significant amount of tips, don't forget to mention that when talking with job candidates about their wage expectations.

What's the Policy?

Like everything else that involves your employees, make sure that everyone is on the same page and understands the policy on the distribution of tips. Write a policy and require employees to sign and date it. The policy should clearly outline eligibility criteria. For example, some florists do not want new employees who are in a trial period to be eligible for tips. (If that's the case, make sure to subtract their hours from the total hours when making the hourly calculation.)

Is Tipping for You?

Tipping can be very profitable for your employees, but it can also come off as pushy if it's not done in a subtle, tactful way. If you decide to jump on the tipping bandwagon, be sure to do it in such a way that the customer feels no obligation to tip. You might also want to talk with a few other florists to learn about their experiences and best practices. 🌿

Paul Goodman, MBA, PFCI, is a former CPA and the founder of *Floral Finance Business Services* based in Tulsa, Oklahoma, editor of *Floral Finance* and author of "The Profit-Minded Florist."

INFLATION, SUPPLY CHAIN ISSUES EXPECTED TO EASE

> Inflation, supply chain stagnation, and other negative effects of ongoing global crises are expected to abate, but the floral industry will likely not see marked improvement until year-end, according to economist Charlie Hall, Ph.D.

Inflation Threats

Economic indicators were on the upswing when the one-two punch of the Omicron variant of COVID-19 hit, followed by the Russian invasion of Ukraine. Pile atop that record inflation not seen since the 1980s and the economy is in rough waters. In February, prices rose year over year by 7.9 percent, the fastest rate of growth in 40 years, according to the U.S. Bureau of Labor Statistics.

All three drivers of inflation — production costs, higher wages, and consumer demand — have occurred, spurred on by the swirling geopolitical and public health crises, says Hall, the Ellison Chair of Floriculture at Texas A&M University.

“We’re having to deal with all three, and all three of these things are leading to inflationary times,” he says. “Many of the florists, wholesale florists and growers that are out there right now — many of them have never managed during inflationary times. It’s been that long since we had this kind of inflation.”

Hall expects that the Federal Reserve’s decision to raise interest rates incrementally throughout the year will help slow the rate of inflation and lessen consumer demand, giving every link of the supply chain time to catch up.

Supply Chain Recovery

COVID-19 has exposed both advantages and shortcomings of the floral industry’s global supply chain, which is beginning to flow more smoothly but is so complex that recovery will be slow at best, Hall says.

“We’re trading flowers and influence all around the world, and we have a globalized supply chain that we spent four decades perfecting,” Hall says. “And then you lay a global pandemic on top of that supply chain. It’s going to cause some wrinkles that are going to take some time to iron out, and we are getting better.”

Major indicators — such as the time it takes to move product through the supply chain from grower to wholesaler to retailer, the volume of product flow, and inventory levels — are all improving from the pandemic trough, he says. It could be December before he expects to see those indicators flashing green again, instead of yellow or red.

“This is a situation that’s going to take the rest of the year to improve because, again, there’s some complex supply chains and you have all this geopolitical maneuvering and stuff that’s happening at the same time,” Hall says. “And so that’s going to delay the improvement in the supply chains, but we’re already seeing it improve.”

Surviving the Short Term

Hall advised business owners faced with higher costs of goods and pressure to increase wages.

“If I am a florist or wholesaler or grower, I am going to make sure I am the employer of choice,” Hall says. “I am going to make sure my wage rates are at

a livable wage. I am going to make sure I provide an atmosphere and culture within my business that people want to come work for me.

“Next, we have to talk about price,” he says. “People are going to have to recognize that as their input costs increase, they are going to have to experiment” with their prices.

Floral professionals worried that consumers won’t pay higher prices for flowers should be buoyed by the data from the U.S. Bureau of Economic Analysis, which shows steady growth in sales of flowers, seeds and potted plants from the second half of 2020 onward. Sales are off to a strong start this year, too, Hall says.

All that growth amid global crisis might show that the floral industry has successfully marketed the benefits of flowers as an essential element of healthy living, Hall says.

“This is a good litmus test of how well we’ve been doing in our marketing, that we have convinced people that we do reduce stress, that we are part of the answer to maintaining positive mental health in this country,” Hall says. “In the midst of a health crisis, it behooves us to emphasize the health-related benefits of flowers in people’s lives. If we do a good job of that, we will make the demand more inelastic. Therefore, we can raise our prices and people won’t cut back their consumption or usage of flowers.”

Amanda Jedlinsky is the senior content strategist for the Society of American Florists and editor in chief of *Floral Management*.

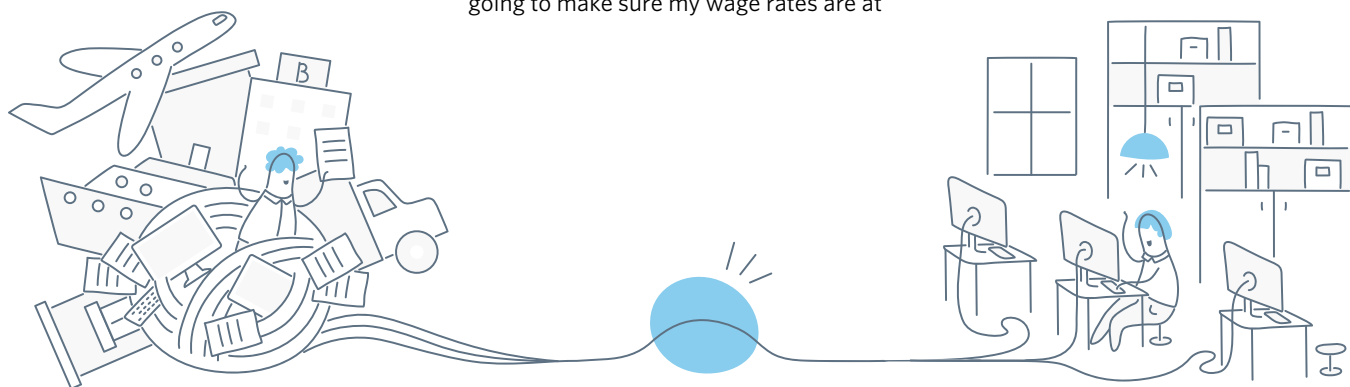

You're Invited!

CALFLOWERS Fun 'N Sun Convention

ALL ABOUT FLOWERS

Grow + Design + Market + Network + Energize

Please join your friends and CalFlowers at San Diego's iconic Hotel del Coronado for one of the premiere conventions in the flower industry.

Meet flower farmers, friends, and colleagues, attend informative programs, and enjoy relaxed networking events.

Bring a friend or colleague - attendees need not be members of CalFlowers to attend.

For more information visit cafgs.org/fns2022



August 29 - September 1, 2022

Hotel del Coronado

Coronado, California

Watch 'Life in Bloom' on TV

CalFlowers supports the flower lifestyle show broadcast nationwide on public television stations.

J Schwanke encourages viewers to enjoy flowers in a variety of ways on a daily basis.

J Schwanke's
Life In
Bloom



CAL FLOWERS™

California Association of
Flower Growers & Shippers



OCEAN FREIGHT STEAMS AHEAD

> Importers in Miami continue to build a reliance on ocean freight for some flowers, especially ahead of floral holidays when the demand for stems is greatest.

The prevalence of ocean freight was particularly apparent during this year's Valentine's Day rush when PortMiami saw double-digit, year-over-year growth in the numbers of stems arriving by ship, according to the Association of Floral Importers of Florida (AFIF). While the number of flowers coming by sea still pales in comparison to air transport (a 2021 survey by the International Fresh Produce Association found that 28 percent of the floral industry is shipping flowers by ocean), sea containers are becoming an important and consistent part of the industry.

"Now, it has become part of the industry," says Steve Daum, director of Superflor Technologies for Floralife, a division of Smithers Oasis. "No way will it replace the airlines, but it isn't going away either. Ocean freight has to work in combined step with the airlines in order for us to have the product we need. It's about working in connection with the needs and logistics and adding to the industry."

The significant volume of flowers required to fill a container means ocean freight plays an important role in

meeting the increased demand ahead of floral holidays, says Christine Boldt, executive vice president of AFIF.

By the Numbers

More flowers were shipped by sea this year ahead of Valentine's Day than last year, according to AFIF. The association reported that 55 million stems entered PortMiami from Jan. 16 to Feb. 5, a 41 percent increase from the same period in 2021, when 39 million stems came through the port.

By comparison, 1.4 billion stems landed at the Miami International Airport from Jan. 1 to Feb. 15, a 17 percent increase from the same period in 2021, according to the airport. The airport receives 91 percent of all flowers imported to the U.S., it says.

Full Steam Ahead

Ocean freight has trended upwards for years because of the logistical costs of air, including competition for space on planes and the need for storage space before and after the flight, Boldt explains. "But the pandemic pushed it further," she says.

With bottlenecks throughout the supply chain, ocean freight isn't a less expensive option, but it offers a solution to the lack of space on planes, Boldt

says. Still, she cautions that there is a risk because of the volume of product in one container. If something goes wrong — from malfunctions with the temperature-controlled shipping containers to the discovery of a pest — it equates to a huge loss of product.

Quality Control

As the use of ocean freight increases, the science behind preparing and caring for the stems during the journey is critical, Daum says. He has worked with growers and transport companies to perfect the logistical timeline and checklists to ensure stems coming by sea still have a 10-day vase life.

"The quality of the flowers is found in the adherence to the protocols we've produced for a well-grown flower to move through the systems," Daum says.

The quality control process for flowers shipped by sea is different than those used for flowers shipped by air — and it works, Daum says. "People are doing things well," he says. "They have bought more infrastructure and are following the steps. There is technology being developed and people are using and enjoying the results."

He points to the outcome of Valentine's Day as an example of success using ocean freight. After all, red roses are one of the flowers known to travel well by sea.

"This year was hugely successful," Daum says of Valentine's Day. "We had a high-quality flower, and sell-through was excellent, with stems lasting 10 days."

Boldt also echoed that the bottom line is about the quality of the flower. While importers must consider the method for importing, she says that most buyers don't.

"They aren't concerned with how it got here," she says. "They are just buying their product. As long as the product is as fresh as possible, and it is what the customer wants, does it really matter how it was transported?" 🌿

Sarah Sampson is a contributing writer for *Floral Management* magazine.



SHUTTERSTOCK.COM/AVIGATOR FORTUNER

Out with the blue and in with the green, our flower food has a fresh **NEW** theme!



**New Design,
New Messaging,
Same great formula!**

Same CHRYSAI formula, guaranteed to give your flowers a boost!
For more information visit: www.chrysal.com

CHRYSAI

MARKET WEDDINGS WITH A UNIQUE DIGITAL SPACE

> It's a great time to grow your wedding business, given that expert wedding sources have estimated there will be up to 2.6 million weddings this year. Considering most of these couples are likely millennials, you need a solid digital strategy to increase your business's online presence. That way, when a couple starts researching venues and vendors on social media or the internet, they'll find and choose you over the competition.

Divide and Conquer

If you're a traditional retail florist, consider segmenting and promoting your wedding work as a distinct business outside of the shop's everyday business. From a digital perspective, this strategy is highly effective because having a marketing focus on weddings enables better

search exposure and results. To take this approach, you'll want to have a separate website and social media accounts exclusively for weddings.

Don Coleman, of Mayfield Florist in Tucson, Arizona, has followed this example with great success. His wedding site ranked second in a recent search for "Tucson wedding flowers," while his shop site ranked seventh. In addition to providing strong online exposure, Coleman says his wedding website also captures information from only serious couples via a submission form that asks for information such as budget, venue, guest count, and poses the question: "What is your vision for the floral and décor package for your event?"

"You will always need to have a conversation with the bride," he says. "It's important your [wedding] website captures their information for consultation. They'll never pick their wedding flowers from your shop website. Whatever site they visit, it's more of a brochure for them to give them ideas."

Persistence of Pinterest

When Coleman's staff connects with a lead, they are sure to ask for a link to the couple's Pinterest board. This helps them quickly gauge the couple's expectations. "We live in Arizona, and need to deal with heat," Coleman says. "We're also currently dealing with supply challenges. If we see they're wanting tulips, peonies or another unavailable variety, we can talk them off the ledge."

Aside from the great consultation intel Pinterest provides, florists can also use the platform to increase visibility of their wedding website. Pinterest allows users to categorize pins, which are photos from a website, onto boards. The pins link back to the website, which boosts the site's search engine optimization (SEO).

Start pinning your wedding photos on Pinterest by categorizing wedding

photo galleries to match typical keywords, styles, or trends that wedding couples may use in search, such as "rustic wedding," "bridal bouquets," or "groom boutonnieres." Then use those photos to create pins on your Pinterest account. It is important to write thoughtful descriptions about the photos that are loaded with keywords and relevant links. This will help other users find your pins, and when your pins are saved to other users' boards, it can potentially drive even more traffic to your website.

Leveraging Social Media

Beyond Pinterest, the biggest social platform millennials use is Instagram. Just as with your wedding website, create a new Instagram account for your wedding business and be sure to link to your wedding website in the bio and start posting photos with relevant hashtags.

Do the same with Facebook. The advantage of using Facebook is you can embed relevant links back to the website. So, if you're sharing photos featuring a popular wedding trend, your post can link back to your web page featuring that trend. If photos feature a venue or a vendor you partner with, be sure to tag them to expose your posts to their audiences as well. 📍

Renato Cruz Sogueco, AAF, PFCI, is vice president of digital strategy at BloomNet, a subsidiary of 1-800-FLOWERS.com, and is a lead instructor at Floriology, a leading industry education center teaching florists innovative floral design and best business practices.

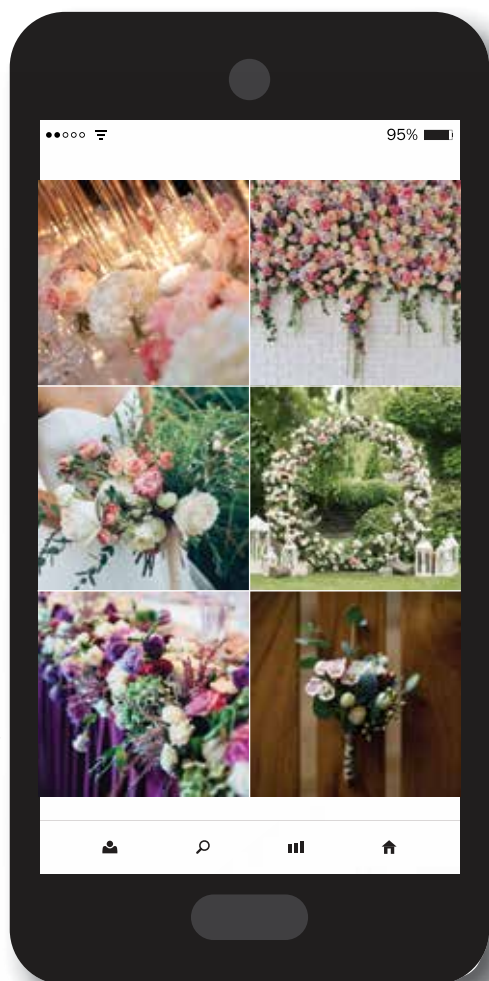

SHUTTERSTOCK.COM/SOIKINA KATERYNA

SHUTTERSTOCK.COM/K.DECOR



Scan for an
Exclusive
SAF
Promotion!



MORE THAN JUST *software...*

Details isn't just a floral software solution that increases your bottom line and frees up your time -- we're your partner. And we love this business as much as you do. We believe that when florists are supported, the whole industry thrives. *(Which is exactly what we're here for!)*

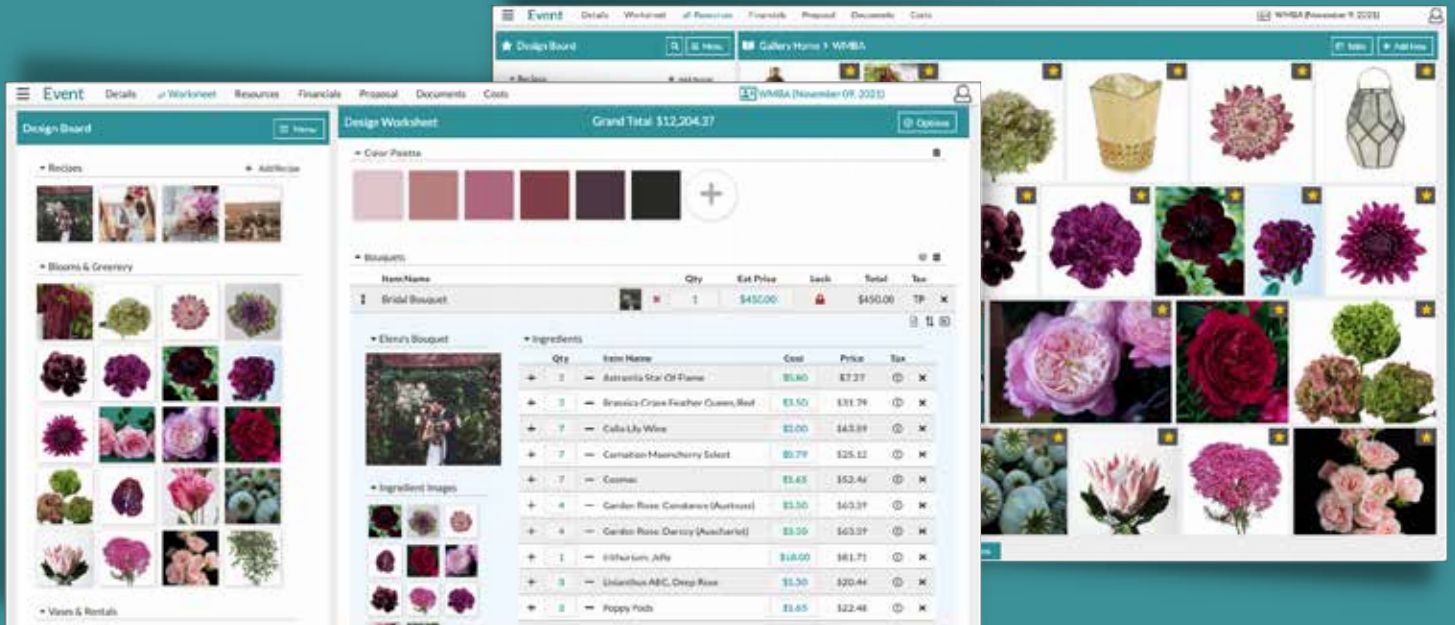

386-255-9594 | detailsflowers.com | @detailsflowers

CLASS ACTS

> Many retailers operate through a series of peaks and valleys tied to holidays. Not Cassie Osterloth, owner of Wonderland Floral Art and Gift Loft in St. Petersburg, Florida. A full calendar of floral workshops (four to six per month) drive customers to her shop week after week.

“We can seat 24 attendees at our workshops, and we are almost always sold out. That brings the profit for each class around \$750. But that’s hardly why this effort pays off so well,” Osterloth says. Upon arrival, participants grab a complimentary glass of wine and walk the showroom, shopping her extensive giftware before class begins. They’ve all become loyal customers who turn to Wonderland for all their floral gifting needs, she says. Many “alumnae” have become bridal clients. Students post photos online, providing impactful (and free) advertising. And it’s given customers much deeper appreciation about the work that goes into floral design, which shuts down the “why do flowers cost so much?” comments.

“Other florists ask me why I would just ‘give away all my secrets’ to help customers do their own arrangements at home. This always makes me laugh,” she says. “I teach them how to do everything — wiring and taping gerberas, braiding grass, building trellises, etc. While they enjoy learning how to do it, they also recognize that these little steps can be quite time consuming, and they’d rather pay a professional to do it for them. If anything, classes have earned us more respect for our work.”

The majority of Osterloth’s classes — dubbed “Floral Therapy” — span two hours and are priced at \$60. “That number really clicks with our clients because they consider it an affordable luxury,” she says. “It’s low enough that they’re willing to treat it as a monthly night out. When you hit the triple digits, people tend to reserve those experiences for special occasions.” Osterloth also offers a few high-ticket specialty classes (“Mad Skills”), which vary in theme and price. Two favorites include a Valentine’s class for couples and a succulent workshop.

Profitability for classes, especially at a \$60 price point, requires working closely with your wholesaler. “With our volume, we can secure great pricing,” Osterloth says. “I also seek out discounted containers to keep that part of my costs as low as possible. Many times, participants return them, so we’re able to use them again for additional profit.” She’s also sure to include a few eye-catching details that add perceived value but don’t increase her costs. “This includes weaving and braiding lily grass, making a trellis from rivercane, constructing a galax leaf flower, curling palm fronds, and making leaf loops from aspidistra,” she says.





SUMMER NIGHTS

Osterloth's clients gravitate to anything with a "tropical flair." Mokara orchids, ginger, and heliconia turn heads in this vibrant, exotic design. "Participants get to use exclusive blooms — not the common dendrobium orchids they see everywhere," she says. "Tropical flowers can be intimidating, so they're happy to have us guide them through the process, and then they get to take home a striking, high-end arrangement." Wholesale costs: \$23. Class price: \$60.

Recipe

1 short tropical bouquet (this one includes ginger, heliconia, aspidistra leaves, and palm)
2 'Calypso' mokara orchids
2 stems of ruscus
2 Robellini palms
3 'Free Spirit' roses
2 stems of solidago
2 stems of asclepias
2 stems of leather leaf
Stone pot
2/3 block of Oasis foam
1 tiki necklace
1 foot of rivercane



PEONY PARADISE “Who doesn’t love peonies? They’re beautiful, fragrant, and exciting to watch bloom,” Osterloth says. “This class is incredibly popular, with some people signing up months in advance to make sure they don’t miss out on working with their favorite flower.” This design also features astilbe (a starring bloom from Meghan Markle’s bridal bouquet) and bupleurum, both of which add texture and visual interest. Wholesale costs: \$28. Class price: \$60.

Recipe

- 3 stems of astilbe
- 6 peonies
- 3 light green hydrangeas
- 2 stems of bupleurum
- 10 stems of leather leaf
- 9-inch Rose Trio vase
- 2 packets of flower food

“They take time to execute, but that’s not an issue when your customers are doing the work, as it would be with your designers during a busy day.” (Osterloth teaches the classes with her sister and co-owner, Missy Barnes, so she doesn’t have to pay an employee to work overtime.)

Years ago, Osterloth advertised her first class — a holiday themed design — with flyers sent out with deliveries. After that, she turned to social media and gave out gift certificates for classes whenever organizations requested donations for silent auctions. “Now, it’s all word of mouth,” she says.

When COVID-19 upended everything in March 2020, Osterloth started offering a “take home” version of her Floral Therapy workshops. “We film and upload to YouTube so participants

can watch at any time during the two-day window when they pick up materials,” she says. “This is much simpler than Zoom or any other live options that could have technical difficulties and leave participants without instruction,” she says. The videos are short (typically about 20 minutes) because she designs without stopping to help students. “At-home participants love that they can pause and rewind to work at their own pace,” she says. Although Osterloth resumed offering in-person classes in November 2020, many customers still opt for the virtual experience. “In December, 90 people signed up for the option — which was like hosting four additional classes with very little work on our end,” she says. 🌿

Katie Vincent is the senior contributing editor of *Floral Management*.

The Society of
American Florists

2 0 2 2

Events!



 **1 DAY PROFIT
BLAST**

Cedar Rapids, IA — June 7
Denver, CO — October 11
San Marcos, TX — November 9



 **NEXT GEN
LIVE!**

JULY 31 - AUGUST 2 | MIAMI, FL

GROW. CONNECT. LEAD.



 **SAF ORLANDO 2022**
137TH CONVENTION | SEPTEMBER 6-8 | HILTON ORLANDO | ORLANDO, FL

Save the Date!

safnow.org/events-education

 **SAF** SOCIETY OF
AMERICAN
FLORISTS
Your Growth is Our Business

SOMETHING FOR EVERYONE



LET YOURSELF BLOOM

Neck protection never looked or felt so good. This bandana, made 100 percent of North Carolina grown and milled cotton, is hand dyed and printed with a hand drawn design of tiny blossoms and the mantra "let yourself bloom." Consider this cute and versatile accessory a talisman for living fully. jenniearle.com



CHILL WITHOUT THE SPILL

There's more than meets the eye with this simple white mug. It's engineered to keep liquid inside through an 83-degree angle, so your coffee (tea, soup, wine, etc.) meets your mouth every time — even if you're reclining on the couch watching Netflix. It also features a tapered neck to maintain heat and intensify beverage aromas, as well as an ergonomic handle. The 14.5-ounce mug, hand finished in a creamy, eco-friendly porcelain, could also work as a vase for a diminutive arrangement or as an elegant pencil holder. relaxxmug.com



CHOCOLATE WITH A KICK

As a single father living in NYC, William Zitser started taking CBD to take the edge off life's everyday stresses. He was excited to find it in chocolate form, but he was let down repeatedly by the taste. This prompted him to make his own. By sourcing the finest single origin cacao from his native Venezuela and other Latin American countries and adding certified organic, hand-cultivated, hemp-derived cannabidiol oil, he created a quality product with an indulgent flavor. enjoyflordemaria.com



WELL WISHES

Wellness is the name of the game for Cast of Stones, which offers a range of products — stone sets, crystals, essential oils, soaking salts, body sprays, jewelry, and home goods — designed to encourage strength, love, happiness, anti-anxiety, health, and success. castofstones.com

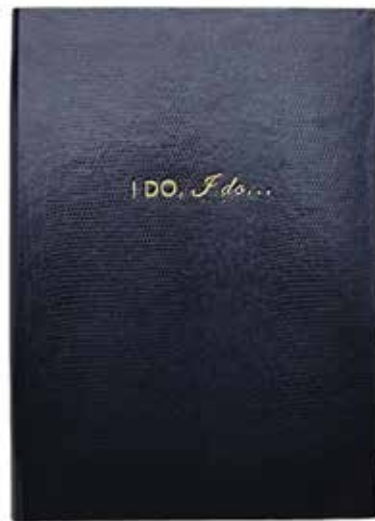

MEMORY KEEPER

These chic notebooks make charming gifts for anyone planning a wedding. Handmade in England by classically trained craftsmen, they feature luxurious cream paper with gold edges, a lizard embossed cover, a grosgrain ribbon bookmark, and an embossed message on front. The wedding collection comes in a variety of sizes, colors and slogans, including "I Do, I Do," "Wedding Checklist," "Something Old, Something New, Something Borrowed, Something Blue," "Forever & Always," "Oui Oui," "Happily Ever After," and "Mother of the Bride." sloanestationary.com

Sheila Santiago is the director of development for the Society of American Florists.

SAF's 28th Annual Marketer of the Year Contest



2019 Winner: J Schwanke, AAF, AIFD, PFCI



2018 Winner: Resendiz Brothers Protea Growers, Fallbrook, California



2017 Winner: The American Crown movement, Santa Barbara, California

Enter SAF's 28th Annual Marketer of the Year contest sponsored by Design Master, a division of Smithers Oasis

Winners receive \$5,000 and will be featured on the cover of the September/October issue of Floral Management magazine.

What makes a winner?

Judges look for innovative and successful marketing efforts. It can be a single campaign, or a series of promotional and advertising efforts over the course of a year or more.

Enter Today!

Submit your marketing campaign online by May 31. To submit your application and view contest criteria visit:

safnow.org/marketeroftheyear

**Entry
deadline:
May 31,
2022**

Questions?

email
sbrady@safnow.org



PREP FLOWERS TO THRIVE AT OUTDOOR EVENTS

> It's Tuesday and the flowers for Saturday's outdoor wedding have arrived. The clock is counting down on the flowers' life. What can you do to not only keep them fresh but also prepare them to withstand the elements of an outdoor wedding?

Time management is critical to ensuring the best flower quality, and the unique demands of outdoor weddings complicate the task. Presenting fresh, vibrant flowers on Saturday depends on using tools and talent wisely.

For outdoor weddings you must consider the elements. Sun, wind and heat will all affect your flowers, primarily in terms of hydration. Here are some tips to make sure the flowers are ready.

Select Flowers Wisely

It is important to work with a reliable and knowledgeable wholesaler or importer who sources flowers from farms that properly harvest, store and transport flowers. If flowers are harvested at the wrong stage of bloom, or aren't kept in the cold chain, there is often little a florist can do to improve the quality of the flower once it reaches them.

It is also important to counsel wedding clients about the types of flowers that will hold up best for their wedding. You could caution your bride that hydrangea, for instance, or the

ever-thirsty bupleurum, is a bad idea on a hot day. You might suggest one of the interesting new varieties of hardy chrysanthemums or carnations. We all know, however, that the bride wants what she wants. If she insists on a potentially troublesome flower, ask your supplier for the hardiest variety. Some varieties within a flower type can offer advantages when it comes to hydration needs and its ability to withstand heat.

Beware of Ethylene

Ethylene lurks throughout the flower chain. Many flowers are naturally ethylene sensitive, and improper handling — as well as higher temperatures — exacerbates their sensitivity. Ethylene can halt flower development — as seen in a rose that doesn't open — and lead to other symptoms such as petal drop and a bent neck. It is important to make sure your supplier has treated your flowers with an ethylene action inhibitor.

Use Flower Food

Getting flowers to open in time for weddings is a primary struggle for wedding florists. Some florists coax flowers open by placing them in warm water or storing them outside the cooler, which shortens their life.

Commercial flower food is the most effective tool to help flowers look their best. From the moment you unpack the boxes of flowers, proper hydration with flower food promotes uptake and encourages the bloom to open, giving you healthier blooms that are ready for the rigors of an outdoor wedding.

Give Greens TLC

It's a common misconception that greens and fillers don't need the TLC flowers receive. Ferns, while hardy, are not indestructible! Exposed to wind and sun, greens and fillers get stressed just like their floral cousins. Proper hydration and storage are key. Finishing sprays can also help by acting as anti-transpirants.

Store Flowers Properly

Properly nourished and hydrated flowers, stored in a cooler between 34 and

38°F with 75 to 85 percent humidity, have the best opportunity to flourish. Avoid temperature fluctuations, and don't forget to space out flowers in the cooler and provide ventilation. Tightly bunched flowers can trap moisture, promoting mold growth and botrytis. A fan can help increase air flow in the cooler, but make sure the fan is not aimed directly at the flowers.

Prevent Damage

Mishandling flowers results in visible damage, but often the damage isn't evident until much later when flowers are already arranged.

Avoid unsightly brown marks and creases on white petals and other types of damage by handling flowers by their stems. Don't overstuff boxes or buckets so that you must force the flower bunches in and out.

If flowers are packed too tightly while transporting them to the wedding, they will most likely crease or bend which will result in browning at those friction points. Secure flowers during transport so that the blooms do not rub against the cardboard or packaging.

Offer Protection

Keep flowers out of direct sun, wind and heat until the last possible moment. Keep the bouquets hydrated and use a finishing spray to lock in moisture, especially on flowers that are out of water.

Take Pride

The flowers' journey from a farm to an outdoor wedding venue is long and hazardous, and they are in your care only briefly. The choices you make and the tools you use will determine the flowers' performance — one that is sure to be noticed by the new couple, the guest who goes home with a centerpiece, and perhaps even a bridesmaid scouting florists for her special day. 🌿

Steve Daum, director of Superflor Technologies for Floralive, a division of Smithers Oasis, has worked in floral production and cut-flower postharvest care and handling for nearly 30 years.





TED WINSTON
WINSTON FLOWERS

FLORAL INDUSTRY LEADERS CHOOSE TELEFLORA

“Teleflora has been a trusted and loyal business partner to Winston Flowers for generations. Teleflora’s best-in-class eFlorist website and point-of-sale technology provide us with tools to exceed our customers’ needs.”

- Best-in-class technology – from POS to eFlorist and order-driving services
- 100% committed to local florists
- Leader in floral advertising and promoting florists in the media

teleflora[®]

myteleflora.com | 1.800.421.2815

© 2020 Teleflora LLC. All Rights Reserved. TELEFLORA is a registered trademark owned by Teleflora LLC. FM200409-07



THE NEW/FTD

SHOP'S RUN ON TECHNOLOGY OF TOMORROW



Your business needs are always evolving—and you should have flexible technology that can keep up. With Mercury HQ, our cloud-based order management system, it's easy to accept orders and run your shop from your personal computer, tablet or smartphone. And with new and improved florist websites, your shop will shine in the e-commerce space.

TO LEARN MORE, VISIT FTDI.COM/NEWFTD